



e-beam®

ENGINEERED LVL
VEINER NUMBER



e-beam®
engineered LVL beams for stick roofs



e-beam®

FACILE LAVORO
VENIRE LA SCELTA

01 CONTENTS

02

e-beam

Technical Information	03
-----------------------	----

11

e-beam

Strutting Beams	12
Strutting – Counter Beams	14
Strutting – Hanging Beams	16
Counter Beams	18
Roof Beams	20

ENGINEERED TO LOAD
ENGINEERED TO LENGTH
ENGINEERED TO LAST

e-beam®

END OF STORY



03

TECHNICAL INFORMATION

e-beam is the premier laminated veneer lumber (LVL) product available in Australia for replacing steel beams in residential roof frames. LVL has many advantages over traditional building products, including lightweight compared to equivalent steel sections, its uniformity of engineering properties, its high strength to weight ratio and its availability in longer lengths.

Available in a range of thicknesses from 45mm to 82mm with depths from 150mm to 450mm, e-beam is manufactured from sustainably sourced timbers, making it an environmentally sustainable resource.

About e-beam

e-beam conforms with the requirements of AS/NZS4357 series - Structural laminated veneer lumber. It is manufactured by laminating sustainably sourced timber veneer, using phenolic adhesive, in a continuous assembly in which the grain direction of all veneers runs longitudinally.

It is pressed as a 1.2m nominal width continuous billet in various standard thicknesses, cut to standard widths and any specified length for use as structural beams and other framing components.

Use of e-beam Data	The Tables and other technical data provided in this publication are only applicable to e-beam LVL manufactured by Wesbeam. This data should not be used for look-alike or substitute products. Use of the e-beam data for look-alike or substitute products can result in unsafe or unsatisfactory performance.
Basis for Design	The design criteria used to develop the Span Tables contained in this brochure are based on the assumptions listed in AS1720.3:2016 - Timber structures, Part 3: Design criteria for timber-framed residential buildings.
Design Loads	<p>The design loads include:</p> <ul style="list-style-type: none"> • Permanent loads • Imposed loads • Wind loads • Snow loads • Earthquake loads, and • Load Combinations of the above loads <p>Design load limitations for each of the above load or load combination cases are also as per AS1720.3:2016 - Timber structures, Part 3: Design criteria for timber-framed residential buildings.</p>
Design Capacity Factor (ϕ)	The capacity factor (ϕ) used to calculate the design capacity of a structural framing member listed in the Span Tables is taken from AS1720.1:2010 - Timber structures, Part 1: Design methods.
Terminology, Definitions and Notations used in these Tables	The terminology, definitions and notations used in this brochure are similar to and consistent with those used and listed in AS1720.3:2016 - Timber structures, Part 3: Design criteria for timber-framed residential buildings, as well as AS1684.2:2010 - Residential timber-framed construction, Part 2: Non-cyclonic areas.
Using Multiple Section LVL Members	The use of multiple sections where called for in the Span Tables is permitted using vertically laminated LVL members. Multiple e-beam LVL members are to be fixed in accordance with the Wesbeam Technical Information Sheet – Multiple Section LVL Members. Reference should also be made to AS1684.2:2010 - Residential timber-framed construction, Part 2: Non-cyclonic areas.
Characteristic Design Values	<p>The characteristic Design Values for Wesbeam LVL are available on request from Wesbeam's Technical Department. This service is available for professional design practitioners.</p> <p>The spans listed in this brochure for LVL manufactured by Wesbeam apply only when the moisture content of the LVL is below 15% in service and are for "on edge" orientation of the LVL section.</p>
e-beam Specification	<p>When fixing LVL manufactured by Wesbeam, treat it exactly the same as seasoned timber. Use the standard edge and end distances and spacings between fasteners appropriate for seasoned softwood timber. You can also use the same fasteners in either the face or edge.</p> <p>Professional design practitioners should use Joint Group JD3 properties as listed in AS1720.1:2010 - Timber structures, Part 1: Design methods to determine the load carrying capacity of nail, screw or bolt fasteners used with e-beam.</p>
Structural Design and Certification	<p>The Span Tables in this publication have been designed in accordance with AS1720.3:2016 - Timber structures, Part 3: Design criteria for timber-framed residential buildings.</p> <p>The Technical data in this publication is Certified by Wesbeam Pty Ltd to be in accordance with AS1684.2:2010 - Residential timber-framed construction, Part 2: Non-cyclonic areas and other relevant Australian Standards.</p>
Cuts, Holes and Notches in LVL Members	Cuts, holes and notched in LVL members manufactured by Wesbeam can be treated exactly the same as those in seasoned sawn timber. Cuts, holes and notches shall not exceed the sizes, nor be at closer spacings than specified in AS1684.2:2010 - Residential timber-framed construction, Part 2: Non-cyclonic areas.

e-beam LVL Comparison to Steel Beam Sections

e-beam LVL has similar member stiffness characteristics to commonly available steel beams. In addition to e-beam LVL beams being checked for serviceability (stiffness) criteria they also need to be checked for strength criteria including bending, shear and bearing.

LVL Size	LVL – $EI_{xx} 10^{12}N.mm^2^*$	Steel UB	Steel – $EI_{xx} 10^{12}N.mm^2$
400 x 63	2.22	180UB16	2.12
400 x 82	3.17	200UB18	3.16

*Note that the LVL stiffness values include the long term creep factor j_2 as per AS 1720.1:2010



EQUALS

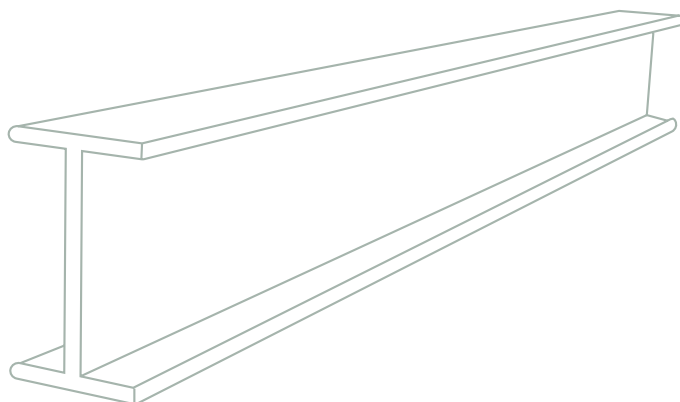

Design Loads

Roof design loads are determined in accordance with AS1684.2:2010 where:

Roof Type	Design Roof Mass (kg/m ²)
Sheet Roof only	20
Sheet Roof + Ceiling	40
Tile Roof only	60
Tile Roof + Ceiling	90

Restraint

All roof beams must be installed in accordance with the requirements of AS1684.2:2010. Part of this requirement is the need for torsional restraint for beams with a depth to breadth ratio exceeding three. The number and position of lateral restraints required for the beam applications listed in this brochure are shown below.

Restraint Locations

Examples of possible beam restraints are illustrated below:

Strutting Beams

Beam lateral restraints required at supports and midspan (at the strut loading point).

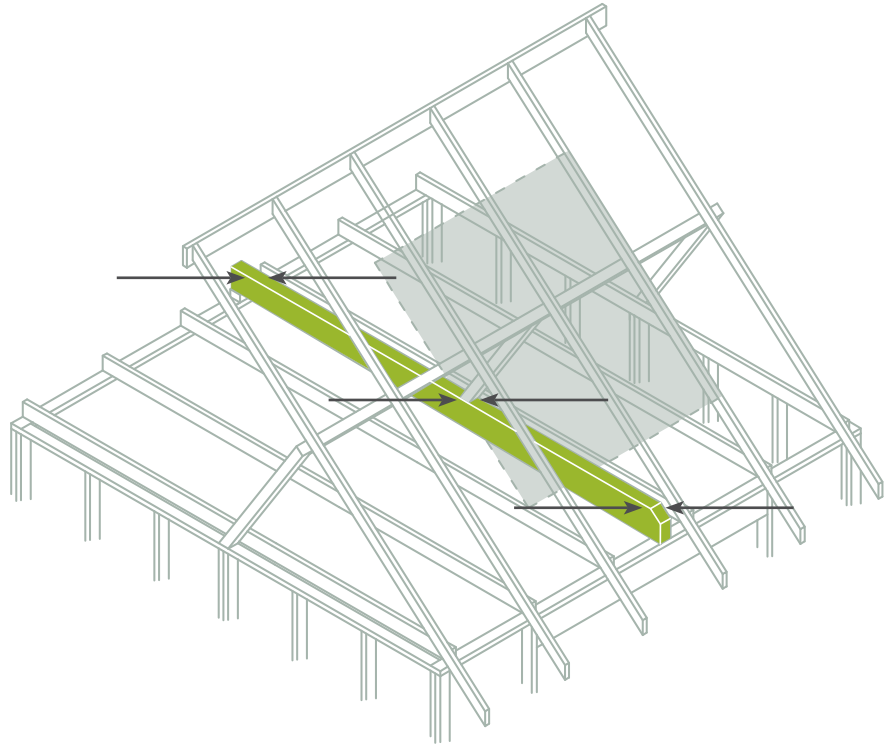

Strutting-Hanging Beams

Beam lateral restraints required at supports and midspan (at the strut loading point).

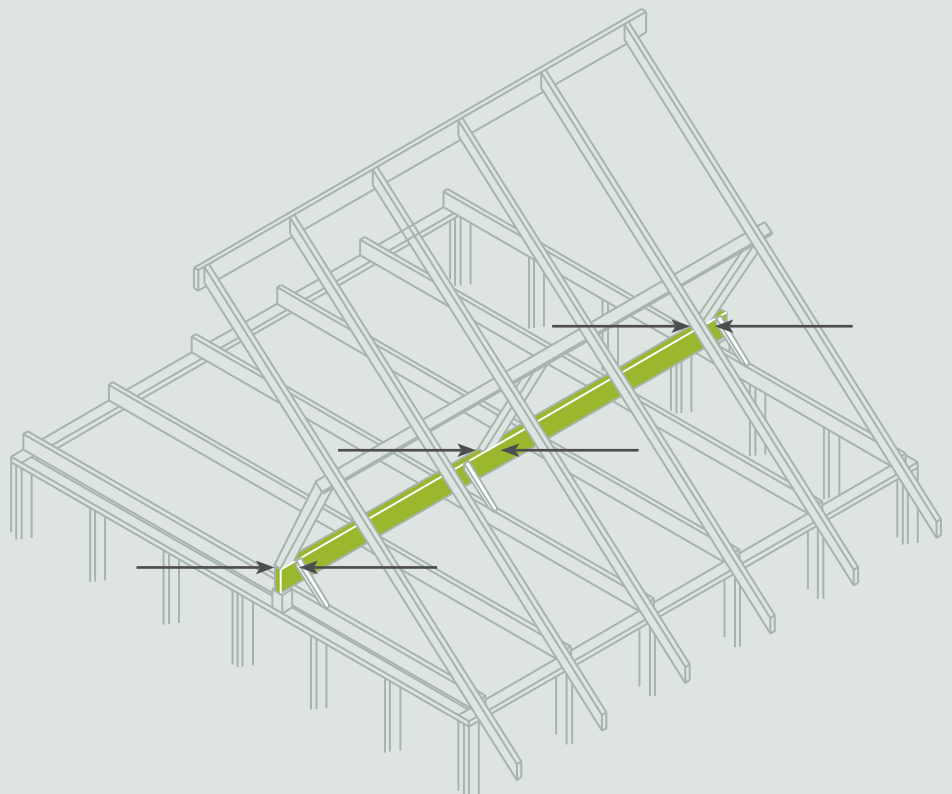

Strutting Counter Beams

Beam lateral restraints required at supports and midspan (by the attachment of the Hanging Beams).

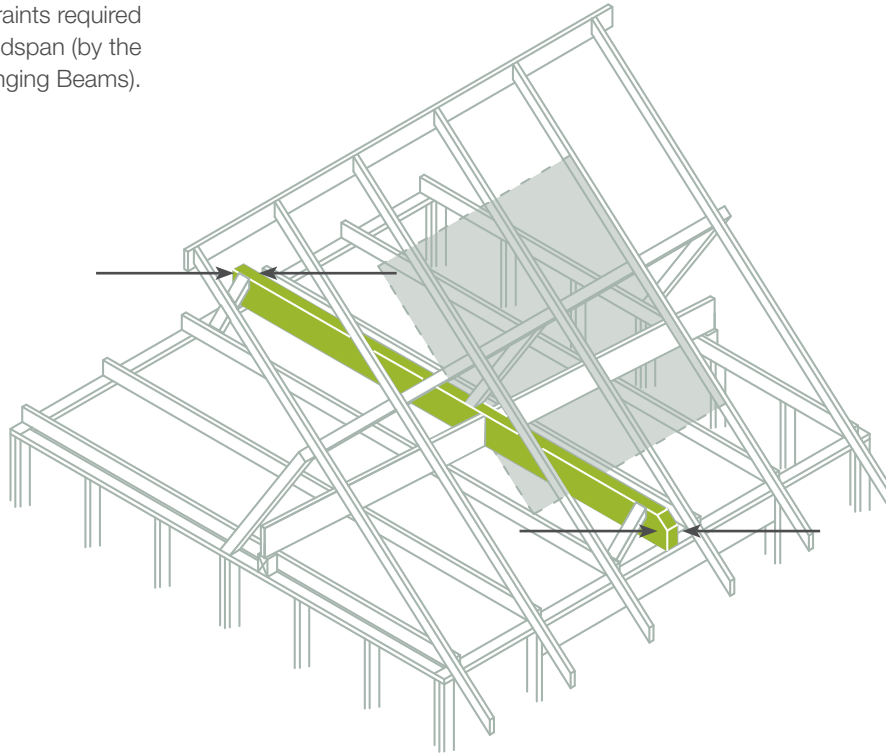

Note: () Denotes position of the roof beam lateral restraint specified in AS 1684.2:2010

Restraint Types

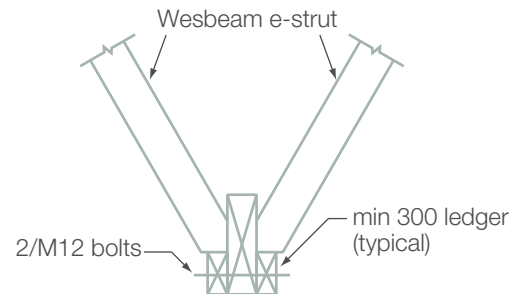
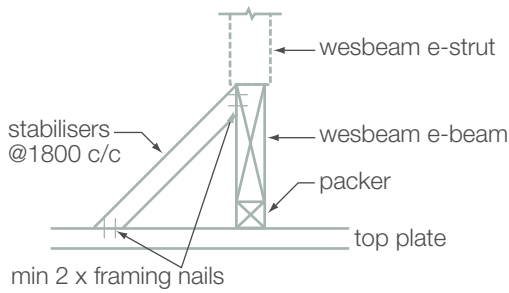
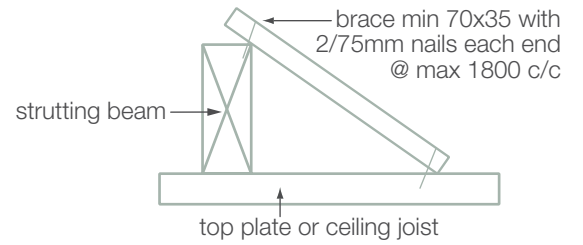
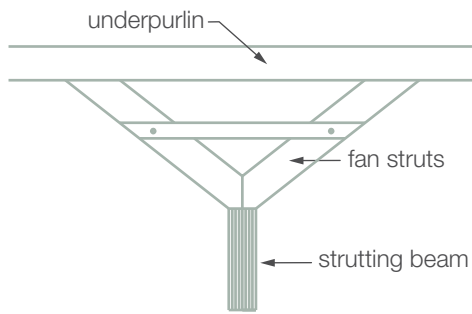
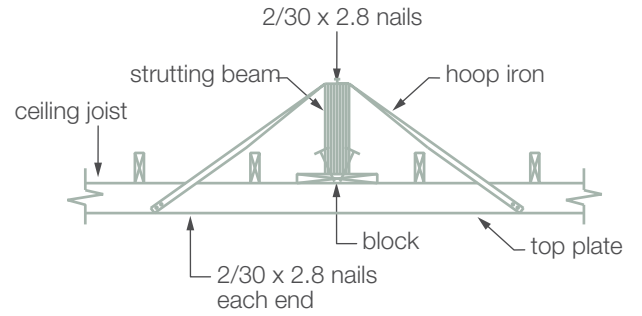
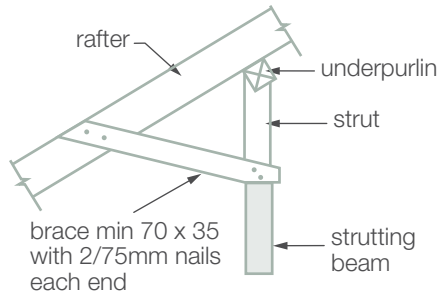

Blocking

e-beam and e-splay Strutting and Strutting/Counter Beams are required by AS1684.2:2010 to be blocked so as to provide 25mm clearance mid span. This clearance may be provided by blocking both ends of the beam up 35mm where rafter depth allows, alternatively blocking up the internal end of e-beam or e-splay beam by 70mm.

BEAM SPANS

Single Span

The span of a member supported at or near both ends with no immediate supports. This also applies where members are partially cut through over intermediate supports to remove spring.

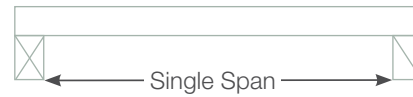

Continuous Spans

Consider the e-beam LVL beam as a continuous span if Span 1 (Major) is not greater than 2 times Span 2 (Minor). If Span 1 is greater than 2 times Span 2 consider the beam as a single span.

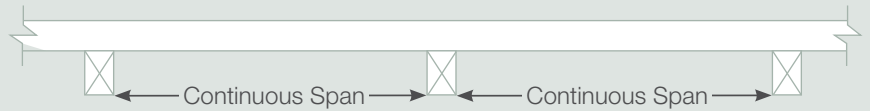

Cantilever Spans

It is permissible to cantilever an e-beam LVL beam. The max. allowable cantilever is 25% of the main e-beam LVL beam span.

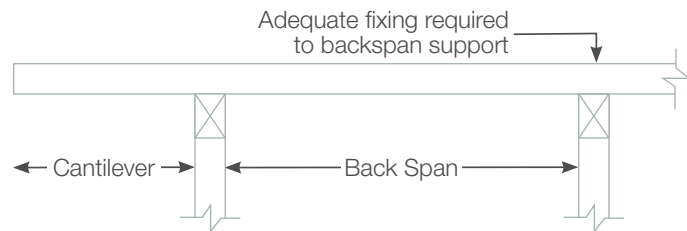

e-beam®
engineered LVL beams for stick roofs



12 STRUTTING BEAMS

SUPPORTING UNDERPURLINS ONLY

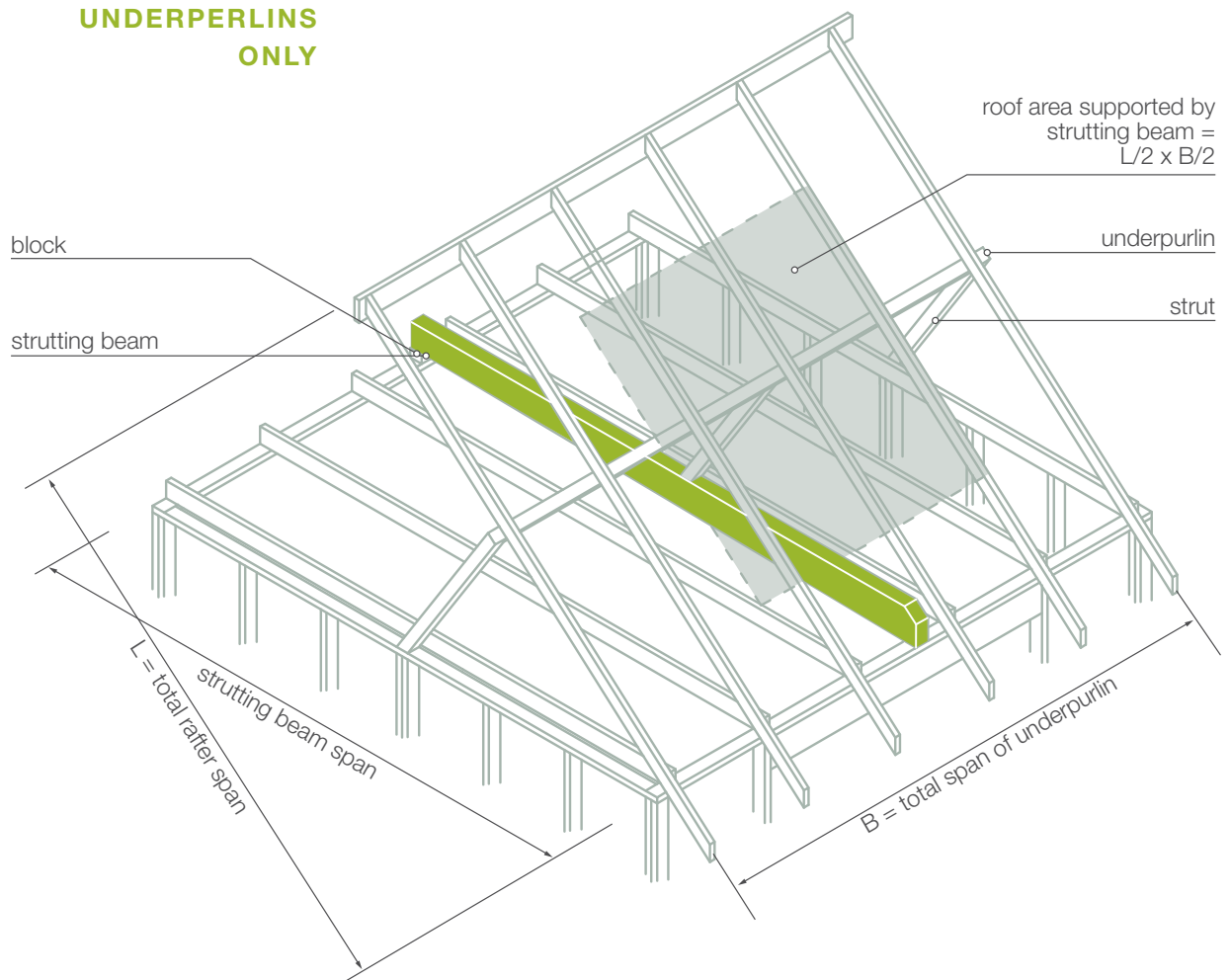

STRUTTING BEAMS

SUPPORTING UNDERPERLINS ONLY

WIND CLASSIFICATION N1, N2, N3

e-beam Section D X B (mm)	Roof Area supported (m ²)								
	2	3	4	5	6	7	8	10	12
	Maximum Span (m)								
Sheet Roof									
150 x 45	4.0	3.7	3.2	2.9	2.7	2.5	2.3	2.1	NS
150 x 63	4.7	4.2	3.7	3.4	3.1	2.9	2.7	2.5	2.3
170 x 45	4.8	4.3	3.8	3.5	3.2	3.0	2.8	2.5	2.2
170 x 63	5.4	4.9	4.4	4.0	3.7	3.5	3.3	2.9	2.7
200 x 63	6.4	6.0	5.5	5.0	4.7	4.4	4.1	3.7	3.4
240 x 45	6.9	6.5	6.1	5.6	5.2	4.9	4.5	3.9	3.5
240 x 63	7.5	7.0	6.6	6.2	5.9	5.6	5.3	4.8	4.4
2/240 x 45	7.9	7.5	7.1	6.8	6.5	6.3	6.1	5.6	5.2
300 x 63	8.9	8.3	7.9	7.5	7.2	7.0	6.7	6.4	6.0
300 x 75	9.1	8.6	8.2	7.8	7.5	7.3	7.0	6.7	6.3
300 x 82	9.2	8.6	8.4	8.1	7.8	7.6	7.4	6.6	6.1
360 x 63	10.0	9.5	9.1	8.7	8.4	8.2	7.9	7.5	7.1
400 x 63	10.7	10.3	9.9	9.5	9.2	8.9	8.6	8.2	7.8
400 x 75	10.9	10.5	10.1	9.8	9.5	9.2	9.0	8.5	8.2
400 x 82	11.1	10.7	10.3	10.0	9.8	9.5	9.3	8.8	8.5
450 x 63	11.6	11.1	10.7	10.4	10.1	9.8	9.5	9.1	8.7
450 x 82	12.6	12.1	11.6	11.3	11.0	10.7	10.3	9.9	9.1
Tile Roof									
150 x 45	3.0	2.5	2.2	NS	NS	NS	NS	NS	NS
150 x 63	3.5	2.9	2.5	2.3	2.1	NS	NS	NS	NS
170 x 45	3.6	3.0	2.6	2.3	2.1	2.0	1.9	NS	NS
170 x 63	4.1	3.5	3.0	2.7	2.5	2.3	2.2	2.0	NS
200 x 63	5.2	4.4	3.8	3.5	3.2	3.0	2.8	2.5	2.3
240 x 45	5.7	4.9	4.3	3.9	3.5	3.3	3.1	2.8	2.5
240 x 63	6.3	5.6	5.0	4.5	4.1	3.9	3.6	3.3	3.0
300 x 63	7.7	7.0	6.5	6.1	5.7	5.3	5.0	4.5	4.1
300 x 75	7.9	7.3	6.8	6.4	6.1	5.7	5.4	4.9	4.5
300 x 82	8.2	7.6	7.1	6.7	6.4	6.1	5.8	5.3	4.9
360 x 63	8.9	8.2	7.6	7.2	6.8	6.6	6.3	5.9	5.4
400 x 63	9.6	8.9	8.3	7.9	7.5	7.2	7.0	6.5	6.2
400 x 75	9.9	9.2	8.7	8.2	7.9	7.6	7.3	6.9	6.5
400 x 82	10.1	9.5	9.1	8.5	8.3	7.9	7.6	7.2	6.8
450 x 63	10.5	9.8	9.2	8.8	8.4	8.0	7.8	7.3	6.9
450 x 82	11.4	10.7	10.0	9.6	9.1	8.7	8.5	7.9	7.5

- 1 All sections with depth to breadth ratio exceeding three must be restrained against rollover at supports.
- 2 All sections with a depth to breadth ratio exceeding three must be laterally restrained at each strutting point in accordance with AS1684.2:2010.
- 3 Multiple sections nail laminated as per AS1684.2:2010.
- 4 A minimum initial clearance of 25mm to ceiling framing members shall be provided at mid-span.
- 5 Bearing length at end supports to be not less than 70mm.
- 6 Beam ends may be chamfer cut to a minimum depth of 90mm or D/3, whichever is greater.
- 7 NS signifies section size unlikely to be suitable.

14

STRUTTING – COUNTER BEAMS

SUPPORTING UNDERPURLINS AND HANGING BEAMS

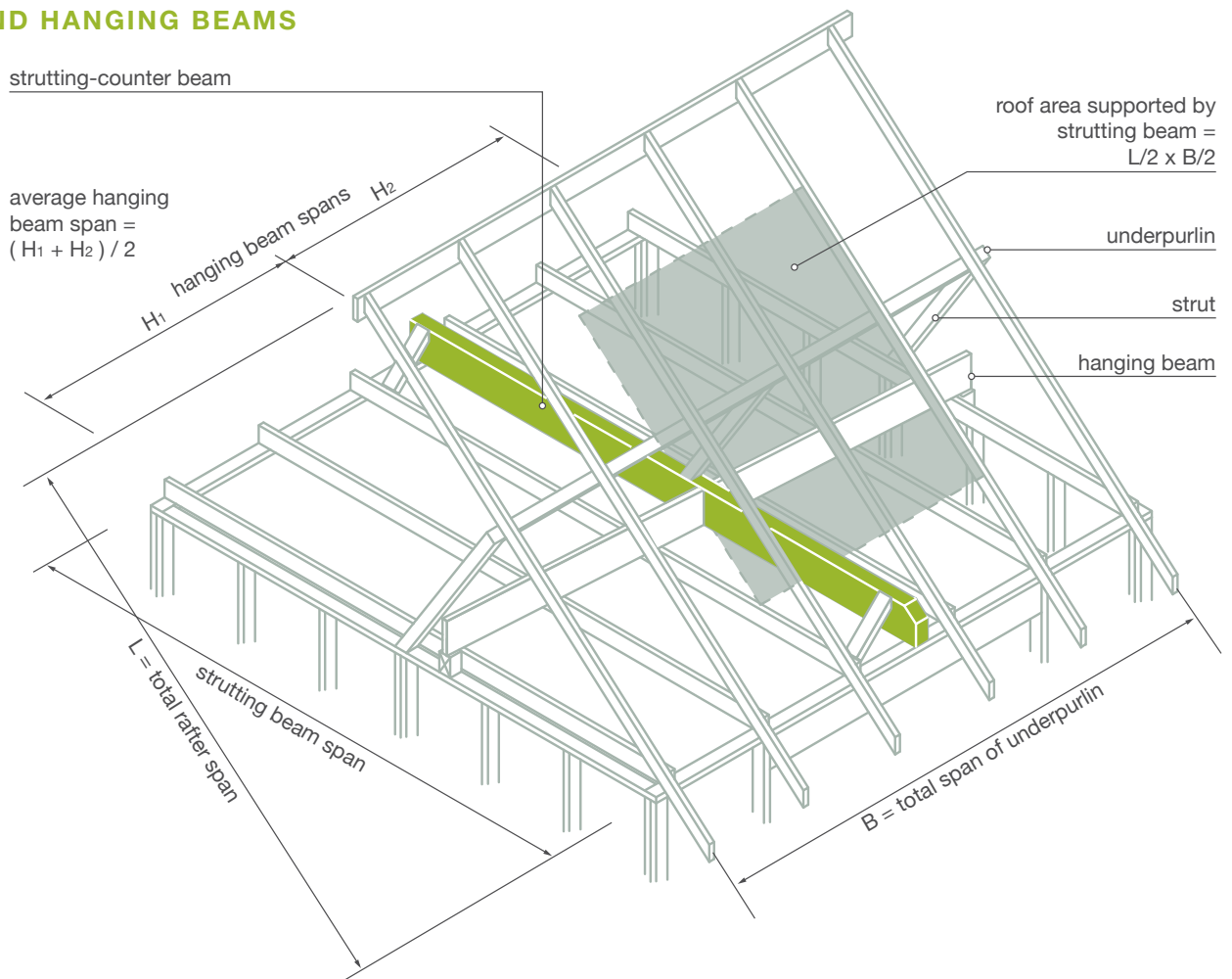

STRUTTING – COUNTER BEAMS

SUPPORTING UNDERPURLINS AND HANGING BEAMS

WIND CLASSIFICATION N1, N2, N3

e-beam Section D X B (mm)	Average Hanging Beam Span (m)											
	2.4						4.2					
	Roof area supported (m ²)											
	2	4	6	8	10	12	2	4	6	8	10	12
Maximum Span for Sheet Roof & Ceiling (m)												
170 x 63	4.0	3.6	3.3	3.0	2.7	2.6	3.7	3.3	3.1	2.8	2.6	2.5
200 x 63	4.5	4.2	3.9	3.7	3.4	3.2	4.2	3.9	3.7	3.5	3.2	3.1
240 x 45	4.8	4.4	4.1	3.9	3.7	3.5	4.4	4.1	3.9	3.7	3.6	3.4
240 x 63	5.2	4.8	4.5	4.3	4.1	3.9	4.8	4.5	4.3	4.1	3.9	3.8
300 x 63	6.1	5.7	5.4	5.2	5.0	4.8	5.6	5.3	5.1	4.9	4.7	4.6
300 x 75	6.3	6.0	5.7	5.4	5.2	5.0	5.8	5.5	5.3	5.1	5.0	4.8
300 x 82	6.5	6.2	5.9	5.7	5.5	5.3	6.0	5.8	5.6	5.4	5.2	5.1
360 x 63	6.9	6.6	6.3	6.0	5.8	5.6	6.3	6.1	5.9	5.7	5.5	5.4
400 x 63	7.4	7.1	6.8	6.6	6.3	6.1	6.8	6.6	6.4	6.2	6.0	5.8
400 x 75	7.7	7.4	7.1	6.8	6.6	6.4	7.1	6.8	6.6	6.4	6.3	6.1
400 x 82	7.9	7.6	7.3	7.1	6.9	6.7	7.3	7.1	6.9	6.7	6.5	6.4
450 x 63	8.1	7.7	7.4	7.2	7.0	6.8	7.4	7.2	7.0	6.8	6.6	6.4
450 x 82	8.6	8.4	8.0	7.8	7.6	7.4	8.0	7.8	7.6	7.4	7.2	7.0
Maximum Span for Tile Roof & Ceiling (m)												
170 x 63	3.5	2.8	2.4	2.1	1.9	NS	3.2	2.7	2.3	2.1	1.9	NS
200 x 63	4.1	3.5	3.0	2.7	2.4	2.2	3.8	3.3	2.9	2.6	2.4	2.2
240 x 45	4.3	3.8	3.3	3.0	2.7	2.5	4.1	3.6	3.2	2.9	2.6	2.4
240 x 63	4.7	4.1	3.8	3.4	3.1	2.9	4.4	4.0	3.7	3.3	3.1	2.8
300 x 63	5.6	5.0	4.6	4.3	4.1	3.9	5.3	4.8	4.5	4.2	4.0	3.8
300 x 75	5.9	5.3	4.8	4.5	4.3	4.1	5.5	5.0	4.7	4.4	4.2	4.0
300 x 82	6.1	5.5	5.1	4.8	4.5	4.3	5.7	5.3	4.9	4.6	4.4	4.2
360 x 63	6.5	5.9	5.4	5.1	4.8	4.6	6.0	5.6	5.2	4.9	4.7	4.5
400 x 63	7.0	6.4	5.9	5.6	5.3	5.0	6.5	6.1	5.7	5.4	5.1	4.9
400 x 75	7.3	6.7	6.2	5.9	5.6	5.3	6.8	6.3	6.0	5.7	5.4	5.2
400 x 82	7.5	7.0	6.5	6.1	5.8	5.5	7.0	6.6	6.2	5.9	5.6	5.4
450 x 63	7.6	7.0	6.6	6.2	5.9	5.6	7.1	6.7	6.3	6.0	5.7	5.5
450 x 82	8.3	7.6	7.2	6.7	6.4	6.1	7.7	7.3	6.9	6.5	6.2	6.0

1 Average Hanging Beam Span = (H1 + H2)/2, where H1 and H2 are the spans of the hanging beams on each side of the Strutting-Counter Beam.

2 All sections with depth to breadth ratio exceeding three must be restrained against rollover at supports/

3 Multiple sections nail laminated as per AS1684.2:2010.

4 Bearing lengths at end supports to be not less than 70mm.

5 Beam ends may be chamfer cut to a minimum depth of 90mm or D/3, whichever is greater.

6 NS signifies section size unlikely to be suitable.

16

STRUTTING – HANGING BEAMS

SUPPORTING UNDERPURLINS AND CEILING JOISTS

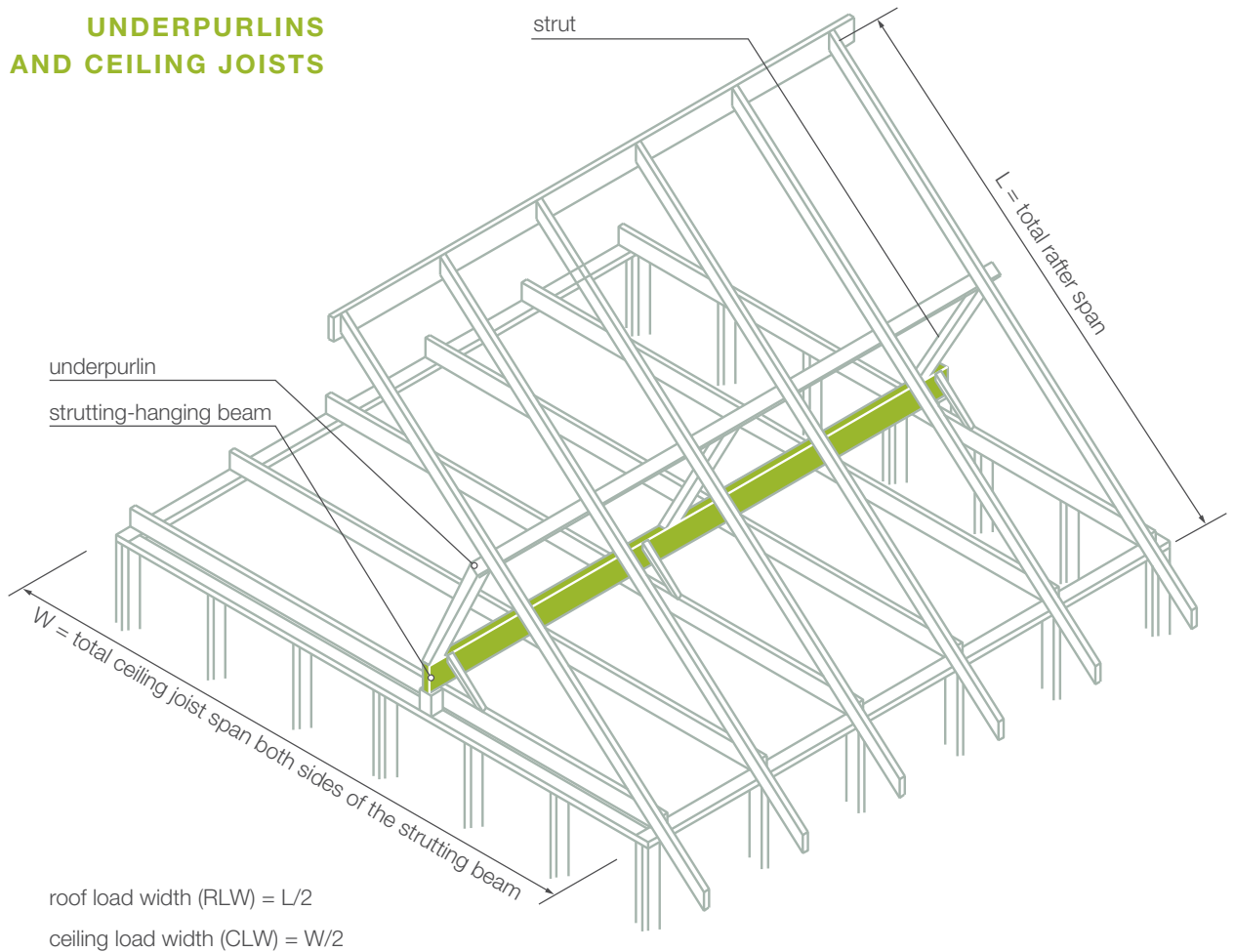

STRUTTING – HANGING BEAMS

SUPPORTING UNDERPURLINS AND CEILING JOISTS

WIND CLASSIFICATION N1, N2, N3

e-beam Section D X B (mm)	Ceiling Load Width 'CLW' (m)											
	1.8				2.4				3.0			
	Roof Load Width 'RLW' for underpurlin (m)											
	1.8	2.4	3.0	3.6	1.8	2.4	3.0	3.6	1.8	2.4	3.0	3.6
Maximum Span for Sheet Roof & Ceiling (m)						Sheet Roof & Ceiling = 40 kg/m²						
170 x 63	3.8	3.6	3.4	3.3	3.6	3.5	3.3	3.2	3.5	3.3	3.2	3.1
200 x 63	4.2	4.1	3.9	3.8	4.1	3.9	3.8	3.7	3.9	3.8	3.7	3.6
240 x 45	4.5	4.3	4.1	4.0	4.3	4.2	4.0	3.9	4.2	4.0	3.9	3.8
240 x 63	4.8	4.6	4.5	4.3	4.7	4.5	4.4	4.2	4.5	4.4	4.2	4.1
300 x 63	5.7	5.4	5.3	5.1	5.5	5.3	5.1	5.0	5.3	5.1	5.0	4.9
300 x 75	5.9	5.7	5.5	5.3	5.7	5.5	5.3	5.2	5.5	5.3	5.2	5.1
300 x 82	5.9	5.7	5.5	5.4	5.7	5.6	5.4	5.3	5.5	5.4	5.3	5.2
360 x 63	6.2	6.0	5.8	5.7	6.0	5.9	5.7	5.6	5.8	5.7	5.6	5.4
400 x 63	6.7	6.4	6.3	6.1	6.5	6.3	6.2	6.0	6.3	6.1	6.0	5.9
400 x 75	7.0	6.7	6.6	6.4	6.8	6.6	6.4	6.2	6.6	6.4	6.2	6.1
400 x 82	7.2	7.0	6.8	6.6	7.0	6.8	6.6	6.5	6.8	6.6	6.5	6.4
450 x 63	7.3	7.1	6.9	6.7	7.1	6.9	6.7	6.5	6.9	6.7	6.5	6.4
450 x 82	8.2	7.9	7.6	7.4	7.9	7.7	7.5	7.3	7.7	7.5	7.3	7.1
Maximum Span for Tile Roof & Ceiling (m)						Tile Roof & Ceiling = 90 kg/m²						
170 x 63	3.2	3.0	2.8	2.6	3.1	2.9	2.7	2.6	3.0	2.8	2.7	2.6
200 x 63	3.7	3.5	3.3	3.1	3.6	3.4	3.2	3.0	3.5	3.3	3.1	3.0
240 x 45	3.9	3.7	3.5	3.3	3.8	3.6	3.4	3.3	3.7	3.6	3.4	3.2
240 x 63	4.2	4.0	3.8	3.7	4.1	3.9	3.8	3.6	4.0	3.9	3.7	3.6
300 x 63	5.0	4.7	4.5	4.3	4.9	4.6	4.4	4.3	4.8	4.6	4.4	4.2
300 x 75	5.2	4.9	4.7	4.5	5.1	4.8	4.6	4.5	5.0	4.7	4.6	4.4
300 x 82	5.3	5.0	4.8	4.7	5.2	4.9	4.8	4.6	5.1	4.9	4.7	4.5
360 x 63	5.6	5.3	5.1	4.9	5.4	5.3	5.0	4.8	5.3	5.1	4.9	4.8
400 x 63	6.0	5.7	5.5	5.3	5.9	5.6	5.4	5.2	5.8	5.5	5.3	5.2
400 x 75	6.2	5.9	5.7	5.5	6.1	5.8	5.6	5.5	6.0	5.7	5.5	5.4
400 x 82	6.5	6.2	6.0	5.8	6.4	6.1	5.9	5.7	6.2	6.0	5.8	5.6
450 x 63	6.5	6.2	6.0	5.8	6.4	6.1	5.9	5.7	6.3	6.0	5.8	5.6
450 x 82	7.3	6.9	6.6	6.4	7.1	6.7	6.5	6.3	7.0	6.6	6.4	6.2

1 All sections with depth to breadth ratio exceeding three must be restrained against rollover at supports.

2 All sections with a depth to breadth ratio exceeding three must be laterally restrained at each strutting point in accordance with AS1684.2:2010.

3 RLW for the underpurlin is the average of the rafter spans on each side of the underpurlin supported by the Strutting-Hanging Beam.

4 Underpurlin span assumed to be one-half the Strutting-Hanging Beam span.

5 CLW is the average of the ceiling joist spans on each side of the Strutting-Hanging Beam.

6 Multiple sections nail laminated as per AS1684.2:2010

7 Bearing length at end supports to be not less than 70mm.

8 Beam ends may be chamfer cut to a minimum depth of 90mm or D/3, whichever is greater.

18 COUNTER BEAMS

SUPPORTING HANGING BEAMS

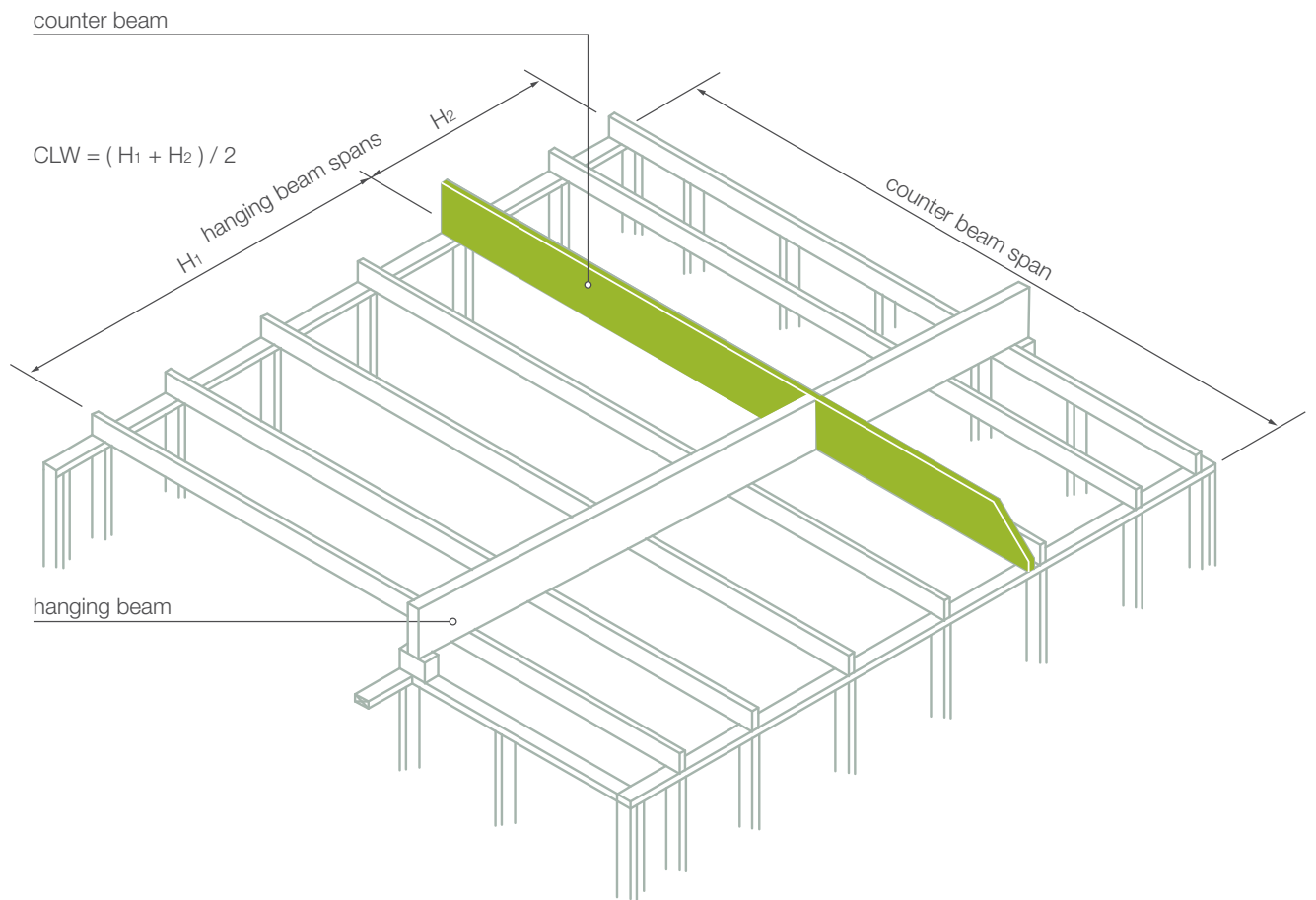

WIND CLASSIFICATION N1, N2, N3

COUNTER BEAMS

SUPPORTING HANGING BEAMS

LIMITS ON DEFLECTION
 PERMANENT LOAD span/300 or 15mm max
 IMPOSED LOAD span/270 or 15mm max

e-beam Section D X B (mm)	Ceiling Load Width 'CLW' (m)							
	1.8	2.4	3.0	3.6	4.2	4.8	5.4	6.0
	Maximum Span (m)							
150 x 35	3.8	3.4	3.2	3.0	2.9	2.8	2.7	2.6
150 x 45	4.0	3.7	3.4	3.3	3.1	3.0	2.9	2.8
170 x 35	4.2	3.9	3.6	3.4	3.3	3.1	3.0	2.8
170 x 45	4.5	4.2	3.9	3.7	3.5	3.4	3.2	3.1
200 x 35	4.8	4.4	4.1	3.8	3.6	3.5	3.2	3.1
200 x 45	5.1	4.8	4.5	4.3	4.1	3.9	3.8	3.7
200 x 63	5.4	5.1	4.9	4.7	4.5	4.4	4.2	4.1
240 x 35	5.2	4.8	4.4	4.1	4.0	3.8	3.6	3.5
240 x 45	5.8	5.4	5.2	5.0	4.8	4.6	4.3	4.2
240 x 63	6.1	5.8	5.6	5.3	5.2	5.0	4.9	4.8
300 x 45	6.7	6.4	6.0	5.6	5.3	5.1	4.8	4.7
300 x 63	7.1	6.8	6.5	6.3	6.1	5.9	5.7	5.6
300 x 75	7.4	7.0	6.7	6.5	6.3	6.1	6.0	5.8
300 x 82	7.6	7.2	6.9	6.7	6.5	6.3	6.2	6.0
360 x 63	8.1	7.7	7.4	7.1	6.9	6.7	6.5	6.4
400 x 63	8.7	8.3	7.9	7.7	7.4	7.2	7.1	6.9
400 x 75	8.9	8.5	8.2	7.9	7.7	7.5	7.3	7.2
400 x 82	9.1	8.7	8.4	8.1	7.9	7.7	7.5	7.3
450 x 63	9.4	8.9	8.6	8.3	8.1	7.9	7.7	7.4
450 x 82	10.0	9.7	9.4	9.0	8.8	8.6	8.4	8.0

- 1 Counter beams to support ceiling loads only – via hanging beams.
- 2 Bearing lengths at end supports to be not less than 70mm.
- 3 Beam ends may be chamfer cut to a minimum depth of 90mm or D/3, whichever is greater.

20 ROOF BEAMS

RIDGE, INTERMEDIATE, EAVE AND BRESSUMMER BEAMS

RIDGE BEAM

ridge beam
rafter

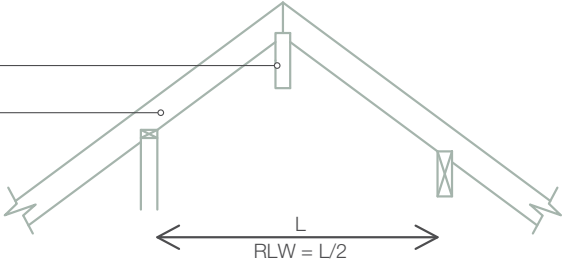

INTERMEDIATE BEAM

rafter
intermediate beam

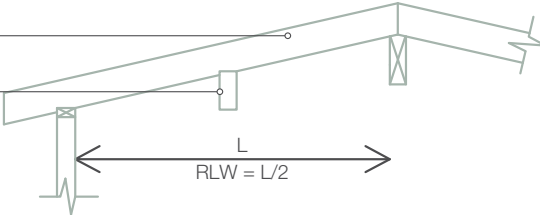

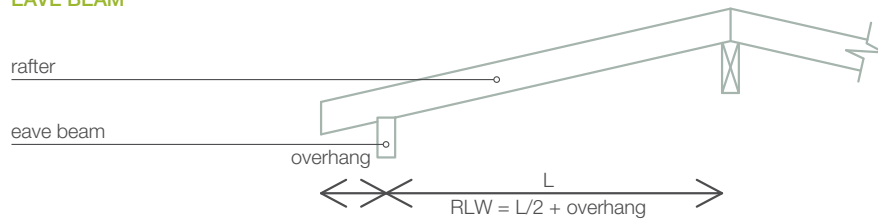
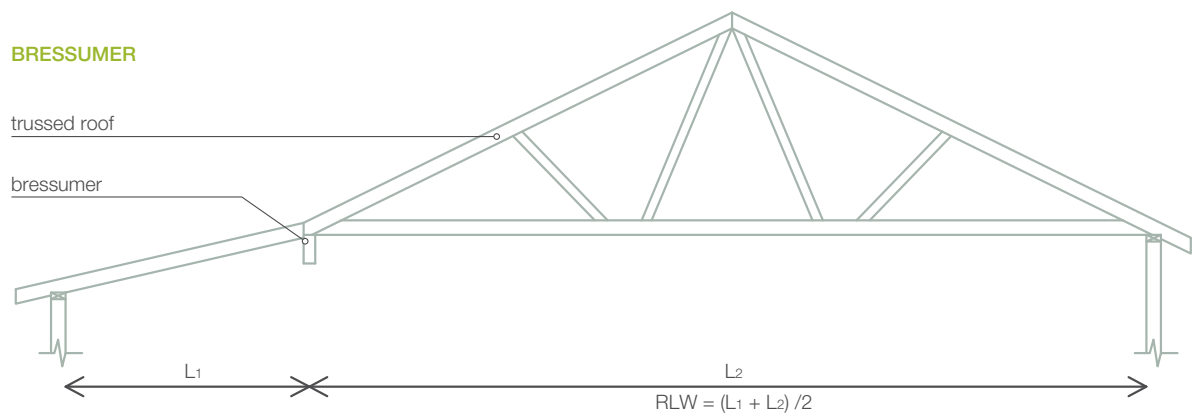
EAVE BEAM**BRESSUMER**

ROOF BEAMS

RIDGE, INTERMEDIATE, EAVE
AND BRESSUMMER BEAMS

WIND CLASSIFICATION N1, N2, N3

e-beam Section D X B (mm)	Sheet Roof and Ceiling											
	Roof Load Width 'RLW' (m)											
	1.8	2.1	2.4	2.7	3.0	3.3	3.6	3.9	4.2	4.8	5.4	6.0
Maximum Single Span (m)												
150 x 35	2.8	2.6	2.5	2.4	2.3	2.2	2.1	2.1	2.0	1.9	1.8	1.8
150 x 45	3.0	2.8	2.7	2.6	2.5	2.4	2.3	2.2	2.2	2.1	2.0	1.9
170 x 35	3.1	3.0	2.8	2.7	2.6	2.5	2.4	2.4	2.3	2.2	2.1	2.0
170 x 45	3.3	3.2	3.0	2.9	2.8	2.7	2.6	2.5	2.5	2.3	2.2	2.1
200 x 35	3.7	3.5	3.3	3.2	3.1	2.9	2.9	2.8	2.7	2.6	2.4	2.3
200 x 45	3.9	3.7	3.5	3.4	3.3	3.2	3.1	3.0	2.9	2.7	2.6	2.5
200 x 63	4.3	4.1	3.9	3.8	3.6	3.5	3.4	3.3	3.2	3.1	2.9	2.8
240 x 35	4.4	4.1	4.0	3.8	3.7	3.5	3.4	3.3	3.2	3.1	2.8	2.7
240 x 45	4.7	4.4	4.2	4.1	3.9	3.8	3.7	3.6	3.5	3.3	3.1	3.0
240 x 63	5.2	4.9	4.7	4.5	4.4	4.2	4.1	4.0	3.9	3.7	3.5	3.4
300 x 45	5.8	5.5	5.3	5.1	4.9	4.7	4.6	4.4	4.3	4.1	3.9	3.8
300 x 63	6.4	6.1	5.8	5.6	5.4	5.2	5.1	4.9	4.8	4.6	4.4	4.2
300 x 75	6.7	6.4	6.2	5.9	5.7	5.5	5.4	5.2	5.1	4.8	4.6	4.4
300 x 82	7.0	6.7	6.5	6.2	6.0	5.8	5.7	5.5	5.4	5.0	4.8	4.6
360 x 63	7.2	6.9	6.7	6.5	6.3	6.3	6.1	5.9	5.7	5.5	5.2	5.0
400 x 63	7.7	7.5	7.2	7.0	6.9	6.7	6.5	6.5	6.4	6.1	5.8	5.6
400 x 75	8.0	7.8	7.5	7.3	7.1	6.9	6.8	6.7	6.5	6.4	6.1	5.9
400 x 82	8.4	8.1	7.8	7.6	7.4	7.2	7.1	7.0	6.9	6.7	6.4	6.2
450 x 63	8.5	8.2	7.9	7.7	7.5	7.3	7.2	7.0	6.9	6.8	6.5	6.3
450 x 82	9.1	8.8	8.5	8.3	8.1	7.9	7.7	7.6	7.4	7.2	7.0	6.7
Maximum Continuous Span (m)												
150 x 35	3.7	3.5	3.3	3.2	3.1	3.0	2.9	2.8	2.7	2.6	2.5	2.3
150 x 45	4.0	3.8	3.6	3.4	3.3	3.2	3.1	3.0	2.9	2.8	2.6	2.5
170 x 35	4.2	4.0	3.8	3.6	3.5	3.4	3.3	3.2	3.1	2.9	2.8	2.6
170 x 45	4.5	4.2	4.1	3.9	3.7	3.6	3.5	3.4	3.3	3.1	3.0	2.9
200 x 35	4.9	4.6	4.4	4.2	4.1	3.9	3.8	3.7	3.5	3.3	3.2	3.0
200 x 45	5.2	5.0	4.8	4.6	4.4	4.2	4.1	4.0	3.9	3.7	3.5	3.4
200 x 63	5.8	5.5	5.3	5.1	4.9	4.7	4.6	4.4	4.3	4.1	3.9	3.8
240 x 35	5.8	5.4	5.1	4.9	4.7	4.4	4.1	4.0	3.8	3.6	3.4	3.2
240 x 45	6.3	6.0	5.7	5.5	5.3	5.1	4.9	4.8	4.6	4.4	4.2	4.0
240 x 63	6.7	6.5	6.3	6.1	5.8	5.7	5.5	5.3	5.2	4.9	4.7	4.5
300 x 45	7.3	7.1	6.8	6.6	6.3	6.1	5.9	5.7	5.5	5.2	5.0	4.7
300 x 63	7.9	7.6	7.4	7.2	7.0	6.8	6.6	6.5	6.4	6.1	5.9	5.6
300 x 75	NS	7.9	7.7	7.5	7.3	7.1	6.9	6.8	6.6	6.5	6.2	5.9
300 x 82	NS	NS	8.0	7.8	7.6	7.4	7.2	7.1	6.9	6.7	6.5	6.3
360 x 63	NS	NS	NS	NS	8.0	7.8	7.6	7.4	7.3	7.0	6.8	6.6
400 x 63	NS	NS	NS	NS	NS	NS	NS	8.0	7.9	7.6	7.3	7.1
400 x 75	NS	NS	NS	NS	NS	NS	NS	NS	NS	7.9	7.6	7.4
400 x 82	NS	NS	NS	NS	NS	NS	NS	NS	NS	NS	8.0	7.8

For Tile Roof and Ceiling, see next page.

1 NS indicates that this span is not available due to manufacturing and transport length limitations.

ROOF BEAMS

RIDGE, INTERMEDIATE, EAVE
AND BRESSUMMER BEAMS

WIND CLASSIFICATION N1, N2, N3

e-beam Section D X B (mm)	Tile Roof and Ceiling											
	Roof Load Width 'RLW' (m)											
	1.8	2.1	2.4	2.7	3.0	3.3	3.6	3.9	4.2	4.8	5.4	6.0
Maximum Single Span (m)												
150 x 35	2.2	2.0	1.9	1.9	1.8	1.7	1.7	1.6	1.6	1.5	1.5	1.4
150 x 45	2.3	2.2	2.1	2.0	1.9	1.9	1.8	1.8	1.7	1.6	1.6	1.5
170 x 35	2.4	2.3	2.2	2.1	2.0	2.0	1.9	1.9	1.8	1.7	1.7	1.6
170 x 45	2.6	2.5	2.4	2.3	2.2	2.1	2.1	2.0	2.0	1.9	1.8	1.7
200 x 35	2.9	2.7	2.6	2.5	2.4	2.3	2.3	2.2	2.1	2.0	1.8	1.8
200 x 45	3.1	2.9	2.8	2.7	2.6	2.5	2.4	2.4	2.3	2.2	2.1	2.0
200 x 63	3.4	3.3	3.1	3.0	2.9	2.8	2.7	2.6	2.6	2.4	2.3	2.3
240 x 35	3.4	3.3	3.1	3.0	2.9	2.7	2.6	2.5	2.4	2.2	2.0	1.9
240 x 45	3.7	3.5	3.3	3.2	3.1	3.0	2.9	2.8	2.8	2.6	2.5	2.4
240 x 63	4.1	3.9	3.7	3.6	3.5	3.3	3.2	3.2	3.1	2.9	2.8	2.7
300 x 45	4.6	4.4	4.2	4.0	3.9	3.7	3.6	3.5	3.4	3.3	3.1	3.0
300 x 63	5.1	4.8	4.6	4.5	4.3	4.2	4.0	3.9	3.8	3.7	3.5	3.4
300 x 75	5.4	5.1	4.9	4.7	4.5	4.4	4.3	4.2	4.1	3.9	3.7	3.6
300 x 82	5.7	5.4	5.2	4.9	4.7	4.6	4.5	4.4	4.3	4.1	3.9	3.8
360 x 63	6.1	5.8	5.5	5.3	5.2	5.0	4.8	4.7	4.6	4.4	4.2	4.0
400 x 63	6.6	6.3	6.1	5.9	5.7	5.5	5.4	5.2	5.1	4.9	4.7	4.5
400 x 75	6.8	6.6	6.4	6.2	6.0	5.8	5.7	5.5	5.4	5.1	4.9	4.7
400 x 82	7.1	6.9	6.7	6.5	6.3	6.1	6.0	5.8	5.7	5.4	5.1	4.9
450 x 63	7.1	6.9	6.7	6.5	6.3	6.2	6.0	5.9	5.7	5.5	5.2	5.0
450 x 82	7.7	7.5	7.2	7.0	6.9	6.7	6.5	6.4	6.2	6.0	5.7	5.5
Maximum Continuous Span (m)												
150 x 35	2.9	2.7	2.6	2.5	2.4	2.3	2.3	2.2	2.1	2.0	1.9	1.8
150 x 45	3.1	2.9	2.8	2.7	2.6	2.5	2.4	2.4	2.3	2.2	2.1	2.0
170 x 35	3.3	3.1	3.0	2.8	2.7	2.6	2.6	2.5	2.4	2.3	2.1	2.0
170 x 45	3.5	3.3	3.2	3.1	2.9	2.9	2.8	2.7	2.6	2.5	2.4	2.3
200 x 35	3.8	3.6	3.5	3.3	3.2	3.1	3.0	2.9	2.8	2.6	2.5	2.3
200 x 45	4.1	3.9	3.7	3.6	3.5	3.4	3.2	3.2	3.1	2.9	2.8	2.7
200 x 63	4.6	4.4	4.2	4.0	3.9	3.7	3.6	3.5	3.4	3.3	3.1	3.0
240 x 35	4.6	4.4	4.1	3.9	3.8	3.5	3.4	3.3	3.2	3.0	2.8	2.6
240 x 45	4.9	4.7	4.5	4.3	4.2	4.0	3.9	3.8	3.7	3.5	3.4	3.1
300 x 63	6.7	6.4	6.2	6.0	5.8	5.6	5.4	5.3	5.1	4.9	4.7	4.5
300 x 75	6.9	6.7	6.5	6.3	6.1	5.9	5.7	5.6	5.4	5.2	5.0	4.8
300 x 82	7.2	7.0	6.8	6.6	6.4	6.2	6.1	6.0	5.9	5.8	5.6	5.4
360 x 63	7.6	7.3	7.1	6.9	6.7	6.5	6.4	6.3	6.2	5.9	5.6	5.3
400 x 63	NS	7.9	7.7	7.4	7.3	7.1	6.9	6.8	6.6	6.3	5.9	5.7
400 x 75	NS	NS	8.0	7.8	7.6	7.4	7.2	7.1	6.9	6.7	6.5	6.3
400 x 82	NS	NS	NS	NS	7.9	7.7	7.5	7.4	7.3	7.0	6.8	6.6
450 x 63	NS	NS	NS	NS	7.9	7.7	7.6	7.4	7.3	7.0	6.8	6.6
450 x 82	NS	NS	NS	NS	NS	NS	NS	NS	7.9	7.6	7.4	7.2

1 The above Span Tables for Roof Beams assume no lateral restraint to the bottom edge under wind uplift conditions.

2 Bearing lengths at end supports to be not less than 70mm.

3 NS indicates that this span is not available due to manufacturing and transport length limitations.

SPECIFICATIONS

Manufacture

Manufactured in accordance with AS/NZS 4357

Veneer

Thickness Constant through the product thickness
Species Sustainably sourced timber
Joints Outer 2 plies are scarf jointed
Inner plies – scarf and/or butt jointed

Moisture Content

8% – 15% (at time of dispatch)

Dimensional Tolerances

Available on request

Straightness

Available on request

Density

650kg/m³ (approximately)

Adhesive

Phenolic – AS2754.1:2016 - Adhesives for timber and timber products; Adhesives for manufacture of plywood and laminated veneer lumber (LVL)

Bond

Type A – AS/NZS2098.2:2012 - Methods of tests for veneer and plywood; Bond quality of plywood (chisel test)

Joint Group

JD3 – for nails, bolts and screws unless noted otherwise

Finish

Unsanded faces, sawn edges and arrised edges

Branding

Each piece of Wesbeam LVL is branded at least once with the product name for identification and evidence of compliance with manufacturing control standards

Storage

Store on level bearers at maximum 1800mm centres well clear of the ground, and cover to keep dry but allow ventilation

Source

Sustainably sourced timber certified to AS4707:2014 - Chain of custody for forest products PEFC

Treatment Condition

Untreated – but can be specified to e2S*, H2 and H3 Treatment levels

*e2S is a CodeMark® certified glue-line termite treatment.



© Wesbeam Pty Limited
ABN 89 004 268 017
WESB0412 August 2020

WESTERN AUSTRALIA

190 Pederick Road
Neerabup | WA | 6031

T 08 9306 0400

F 08 9306 0444

E sales.wa@wesbeam.com

QUEENSLAND

3 Bult Drive
Brendale | QLD | 4500

T 07 3385 3900

F 07 3385 3911

E sales.qld@wesbeam.com

SOUTH AUSTRALIA

200 Cavan Road
Dry Creek | SA | 5094

T 08 8214 8500

F 08 8349 7212

E sales.sa@wesbeam.com

VICTORIA

Rear | 35 Greens Road
Dandenong South | VIC | 3175

T 03 8782 9500

F 03 8782 9511

E sales.vic@wesbeam.com

NEW SOUTH WALES

8-24 Dunheved Circuit
St Marys | NSW | 2760

T 02 8856 8400

F 02 9756 3793

E sales.nsw@wesbeam.com

DESIGN CENTRE

3 Bult Drive
Brendale | QLD | 4500

T 1300 356 460

E design@wesbeam.com